

NORMAS E GARANTIAS DE CONFORMIDADE

Com o intuito de respeitarmos a Norma EN 14195, submetemos durante todo o processo de fabricação dos nossos produtos a um rigoroso controle de qualidade.

Todos os nossos produtos estão conforme a norma europeia EN 14195. A GramPerfil tem a certificação ISO 9001 e ISO 14001.

NORMES ET GARANTIES DE CONFORMITÉS

Afin de garantir et de respecter les normes EN 14195, nos profilés sont soumis pendant toute la durée de fabrication à un rigoureux contrôle de qualité.

Tous nos produits sont conforme aux Norme européenne EN 14195. GramPerfil est certifiée ISO 9001 et ISO 14001.



[ÍNDICE SOMMAIRE]

MONTANTE MONTANT	2
RAIA RAIL	3
GAMA DIN	5
PERFIL TECTO FOURRURE	6
CANTONEIRA CORNIÈRE	9
OMEGA / LISSE	10
ACESSÓRIOS ACCESSOIRES	11
VIGA LONGUE PORTÉE	13
ACESSÓRIOS PARA VIGA ACCESSOIRES POUR VIGA	15
TABELA DE CARGA LONGO PORTE "VIGA" TABLEAU DES CHARGES LONGUE PORTÉE "VIGA"	16
LOGÍSTICA LOGISTIQUE	17



**CERTIFICAÇÃO DE PRODUTO:
MARCAÇÃO CE
SEGUNDO EN 14195**



**CERTIFICAÇÃO DE PRODUTO:
CERTIFICAÇÃO NF
SEGUNDO AFNOR NF 411**

<http://evaluation.cstb.fr>



Management
System
ISO 9001:2015
ISO 14001:2015

www.tuv.com
ID 9105055109

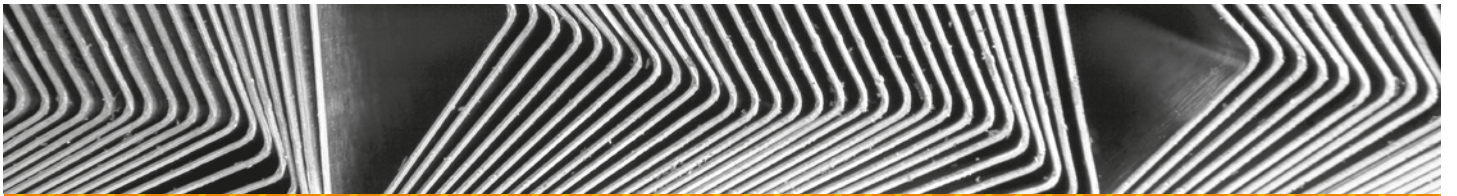

[**MONTANTE E RAIA**]

[MONTANT ET RAIL]



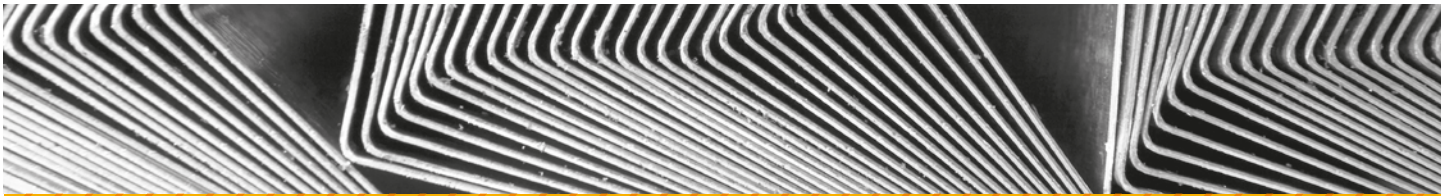

[**MONTANTE**]

[MONTANT]



CE

NF

DIN



Produto / Produit		M 36	M 48			M 62			M 70			M 90			M 100		
Aba / Ailes		40	35	40	50	35	40	50	35	40	50	35	40	50	35	40	50
Furação / Perforation		Ø 18	Ø 25			Ø 25			Ø 35			Ø 35			Ø 35		
Qtd Palete / Qte Palette		500	540	450	360	420	350	280	360	300	240	300	250	200	240	200	160
Norma	CE	✓	✓	✓	✓	✓	✓	✓	✓	✓	✓	✓	✓	✓	✓	✓	✓
Norme	NF	✓	✓		✓	✓	✓	✓	✓	✓	✓	✓	✓		✓	✓	

Produto / Produit		CW 50	CW 75	CW 100	CW 125	CW 150
Aba / Ailes		50	50	50	50	50
Furação / Perforation		H	H	H	H	H
Qtd Palete / Qte Palette		320	220	176	132	132
Norma / Norme <u>DIN</u>		✓	✓	✓	✓	✓

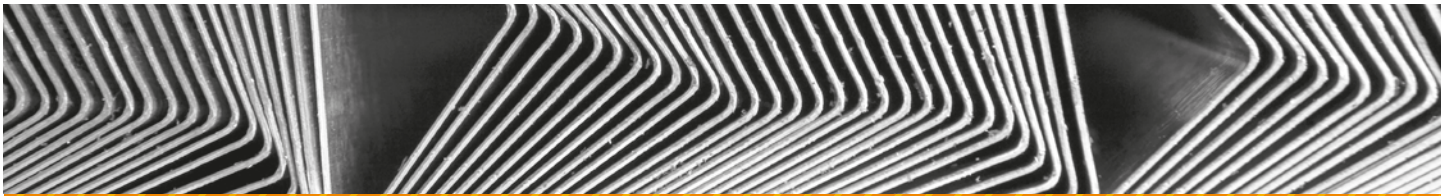

[**RAIA**]

[RAIL]



Produto / Produit		R 36		R 48		R 62		R 70		R 90		R 100	
Aba / Ailes		26	28	26	28	26	28	26	28	26	28	26	28
Qtd Paleta / Qte Palette		480	420	560	560	560	490	480	420	400	350	320	280
Norma	CE	✓	✓	✓	✓	✓	✓	✓	✓	✓	✓	✓	✓
Norme	NF		✓		✓		✓		✓		✓		✓

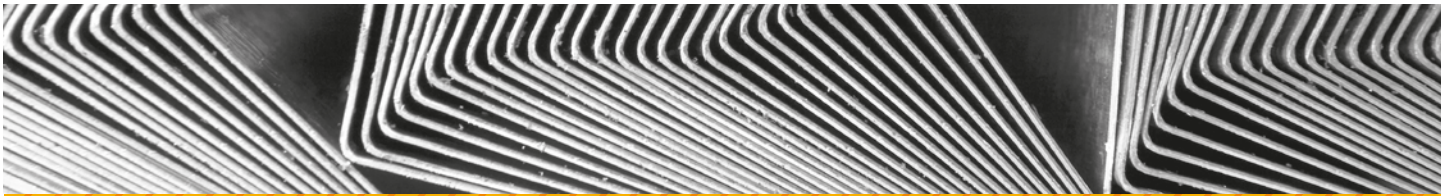

[RAIA]

[RAIL]



DIN

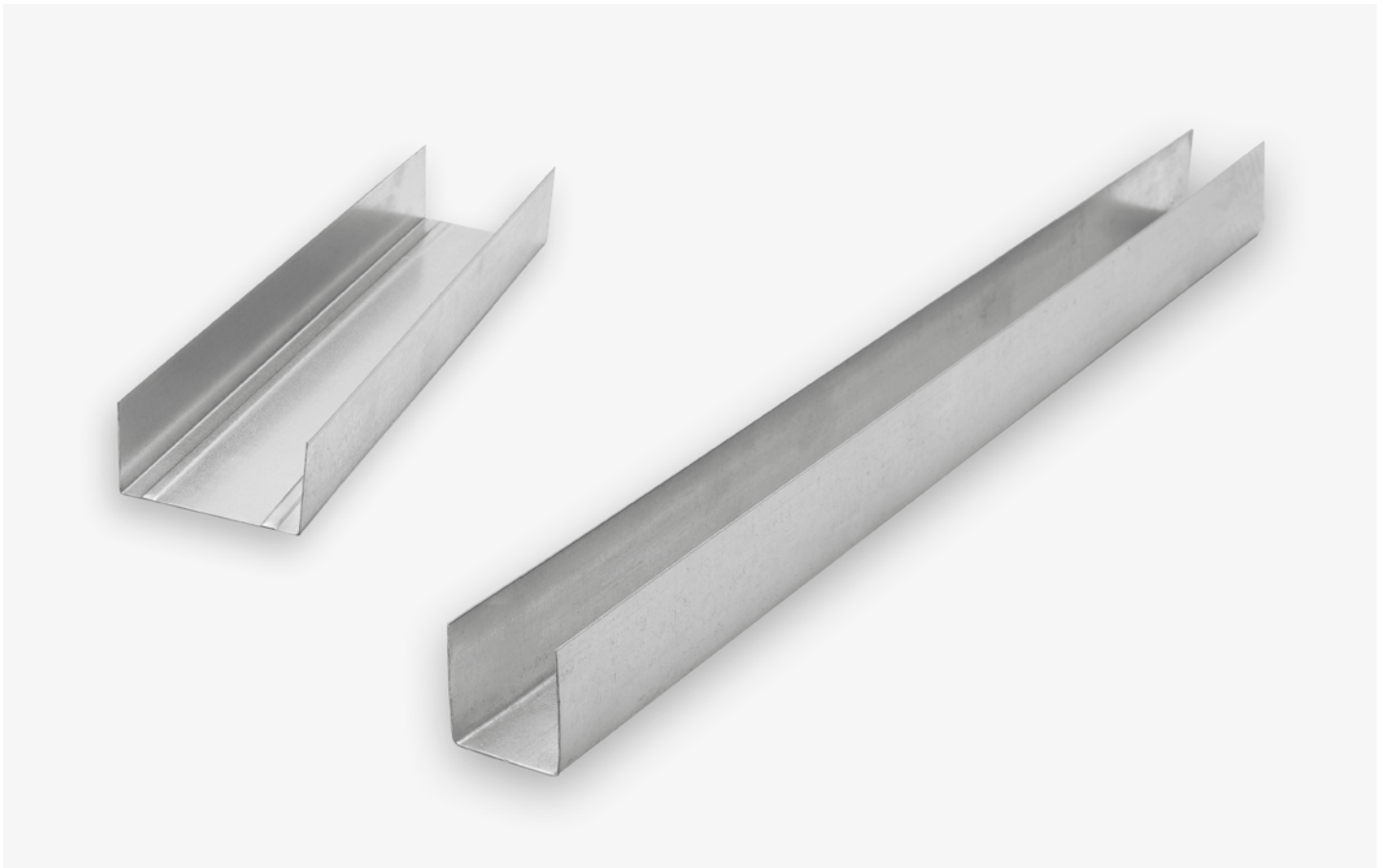

Produto / Produit	UW 50	UW 75	UW 100	UW 125	UW 150
Aba / Ailes	40	40	40	40	40
Qtd Palete / Qte Palette	448	336	224	156	156
Norma / Norme <u>DIN</u>	✓	✓	✓	✓	✓

Produto / Produit	UA 30		UA 54	UA 85	UA 120
Aba / Ailes	30 / 30	30 / 40	40	40	40
Qtd Palete / Qte Palette	360		360	300	240
Norma / Norme <u>DIN</u>	✓		✓	✓	✓

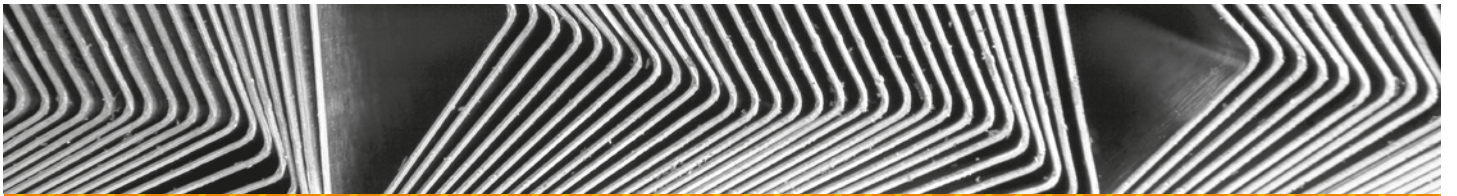

[**PERFIL DE TECTO**]

[FOURRURE]



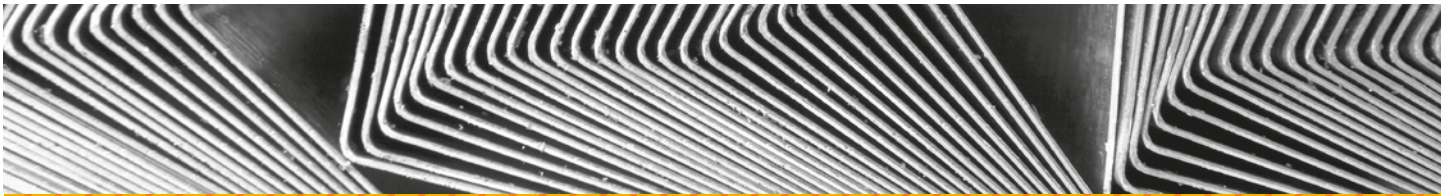

[**PERFIL DE TECTO**]
[FOURRURE]

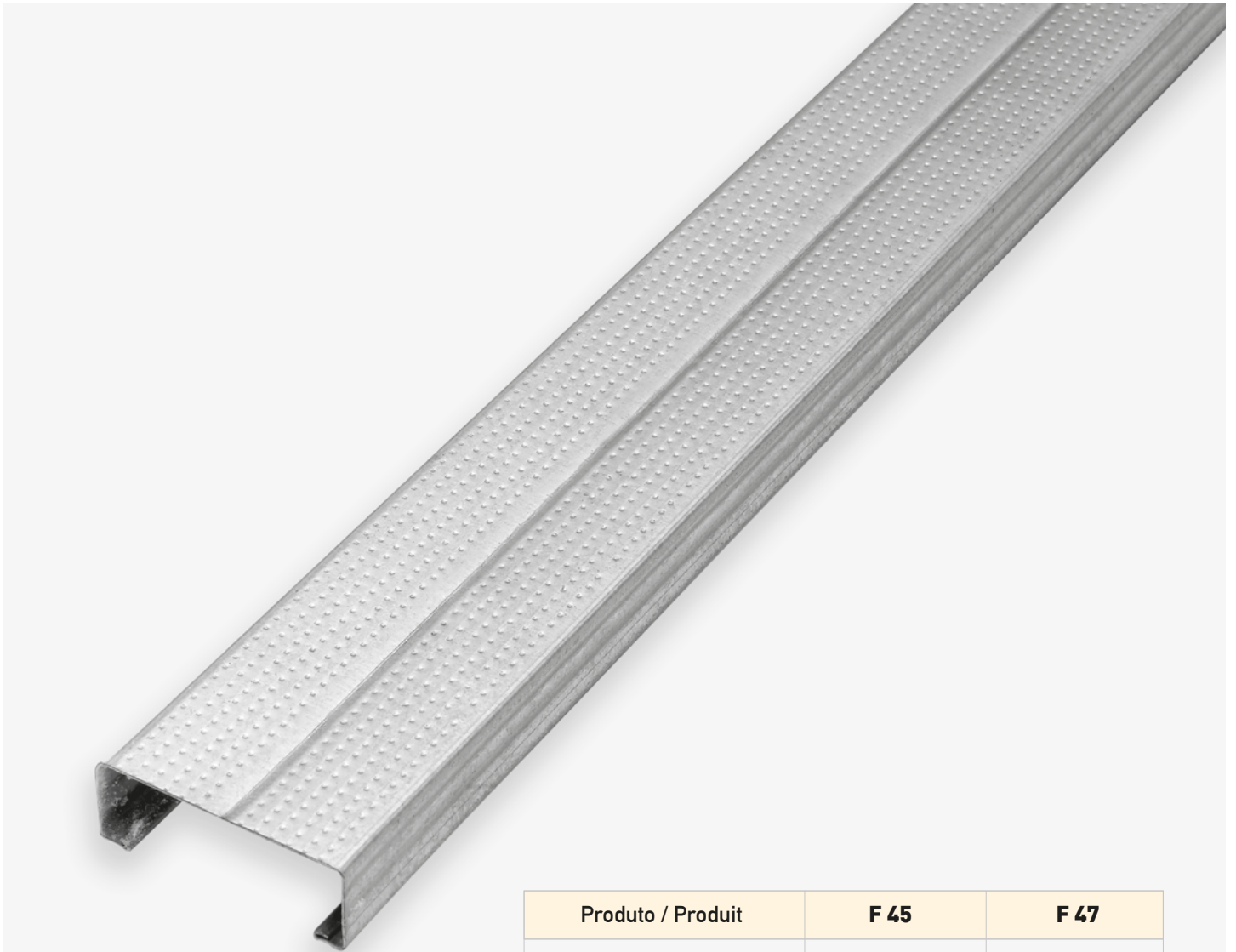

Produto / Produit		F 45	F 47
Aba / Ailes		18	17
Comprimento Longueur		≤ 4000mm - 600 uni. > 4000mm - 360 uni.	
Norma	CE	✓	✓
Norme	NF	✓	✓

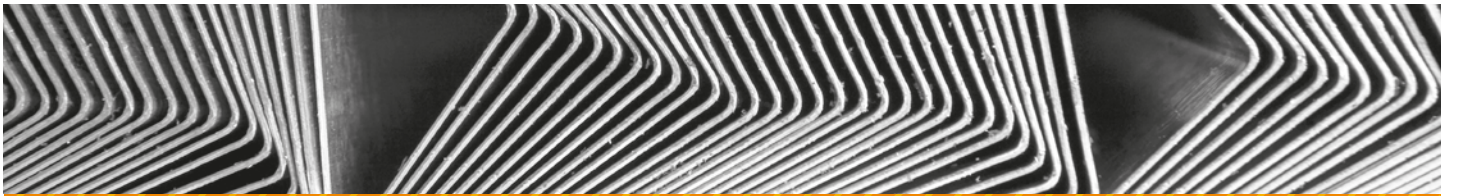

[**PERFIL DE TECTO**]

[FOURRURE]



DIN

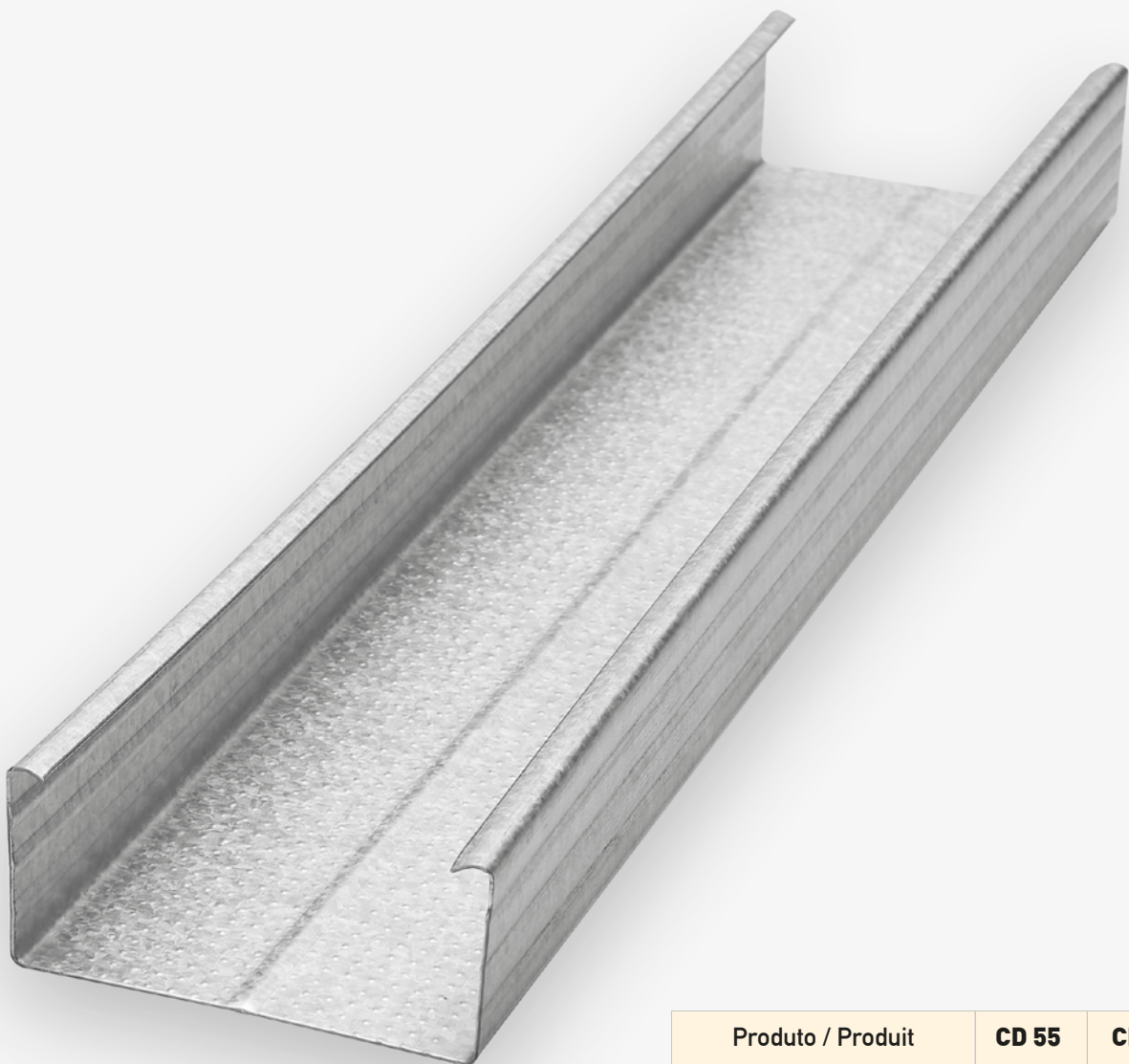

Produto / Produit	CD 55	CD 60
Aba / Ailes	18	27
Qtd Paleta / Qte Palette	600	400
Norma / Norme <u>DIN</u>	✓	✓

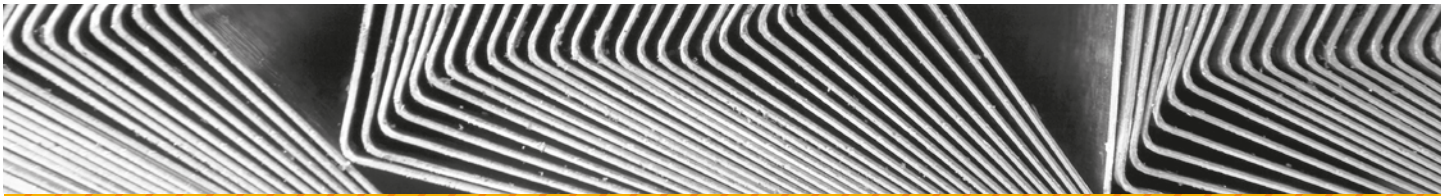

[**CANTONEIRA**]
[CORNIERE]

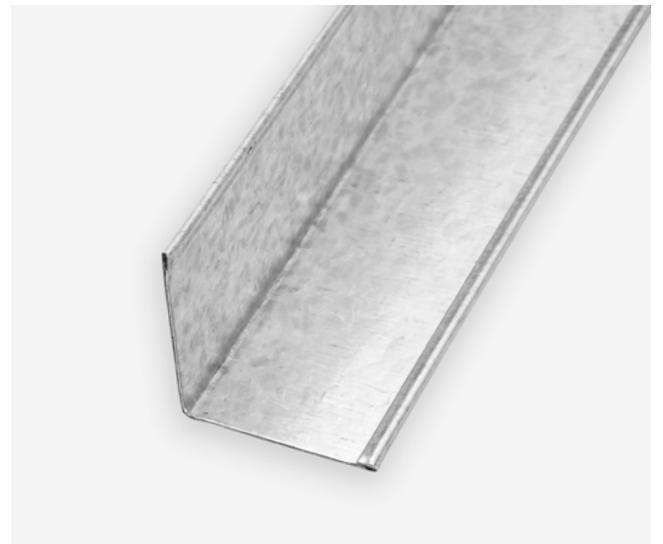
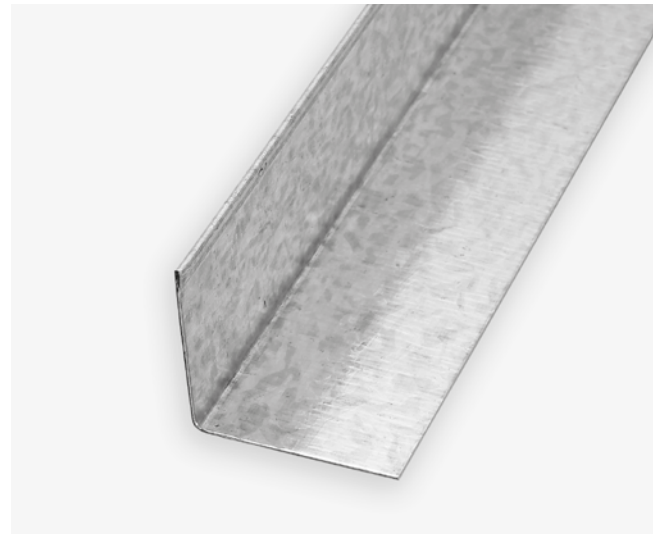

Produto / Produit		C 0				C 1 / CR2				C 2	
Aba / Ailes		30 / 30	35 / 24	40 / 30	50 / 30	30 / 30	35 / 24	40 / 40	50 / 30	30 / 30	35 / 24
Qtd Paleta / Qte Palette		1560		760		1020		1000		1020	
Norma	CE	✓	✓	✓	✓	✓	✓	✓	✓	✓	✓
Norme	NF						✓				

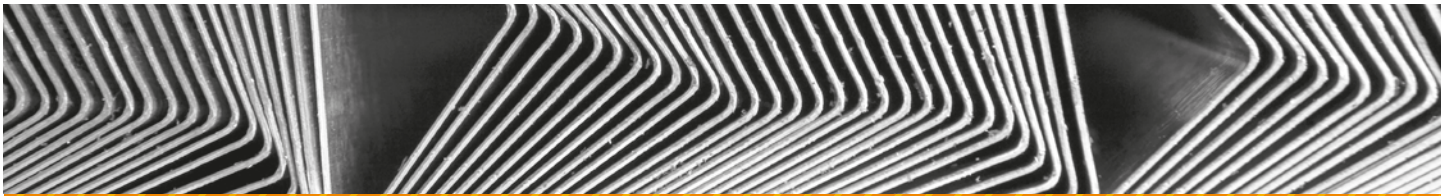

[**OMEGA**]
[LISSE]

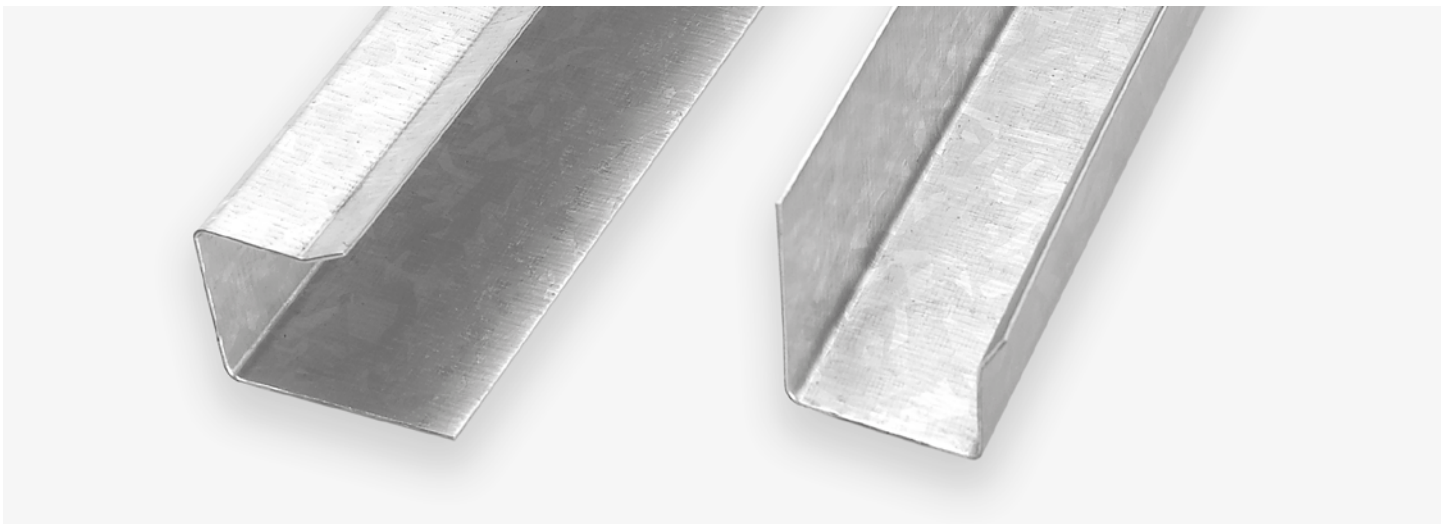
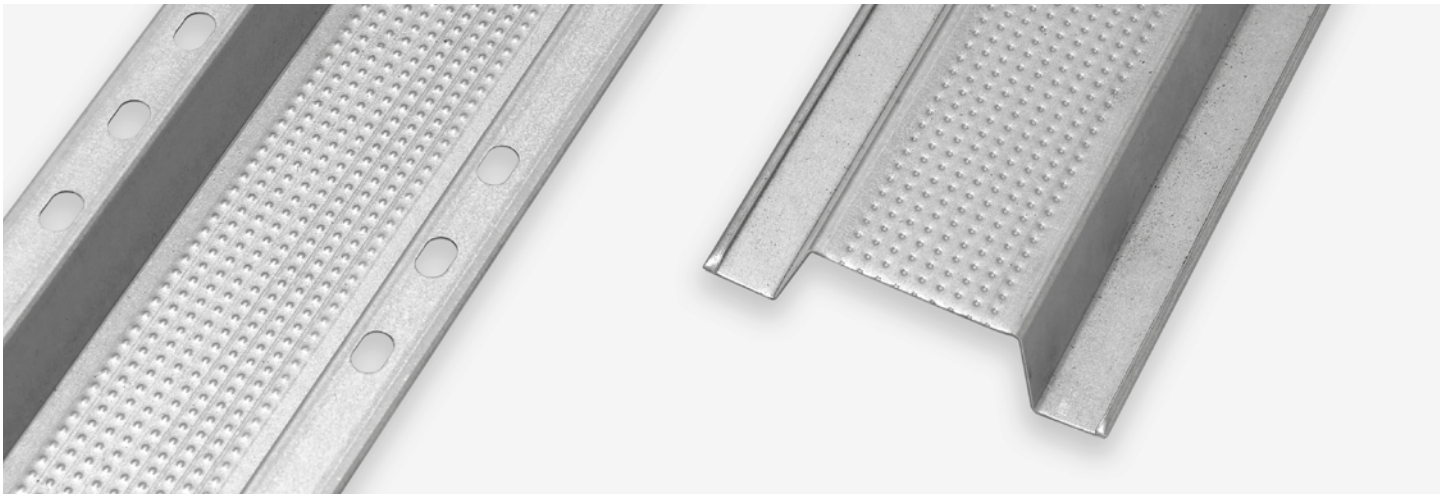

Produto / Produit		OMEGA 68	
Aba / Ailes		17	
Furação / Perforation		Ø 5 x 8	X
Qtd Paleta / Qte Palette		640	
Norma	CE	✓	
Norme	NF		✓

Produto / Produit		LISSE 19	
Aba / Ailes		28 / 17	
Furação / Perforation		Ø 6	
Qtd Paleta / Qte Palette		560	
Norma	CE	✓	
Norme	NF		✓

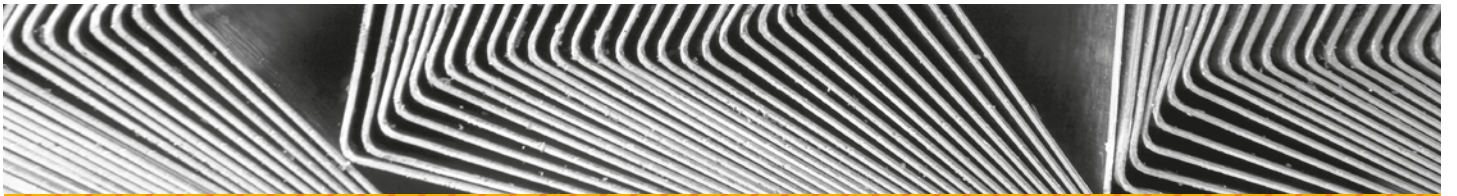

[**ACESSÓRIOS**]

[ACCESSOIRES]

CE



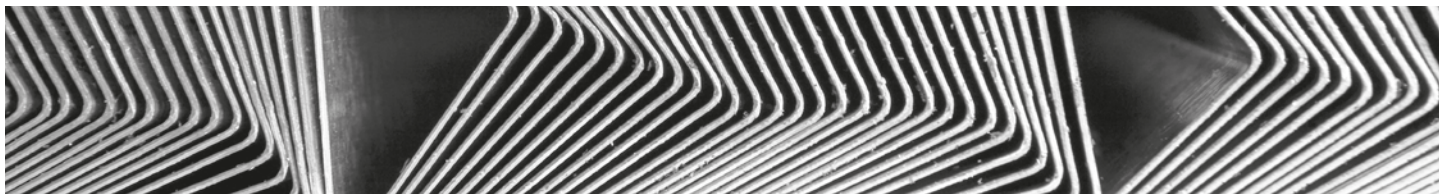

[ACESSÓRIOS]

[ACCESSOIRES]

CE

DESIGNAÇÃO DÉSIGNATION	45/47	QUANTIDADE POR CAIXA QUANTITÉ PAR BOÎTE
Emenda / Raccord	45/47	50
Cavaliér	45/47	50
Cavaliér viga	45/47	50
Pivot	45/47	100
Susp. 90	45/47	100
Susp. 190	45/47	100
Susp. 240	45/47	50
Susp. 300	45/47	50
Susp. 400	45/47	50
Susp. 480	45/47	50
Susp. longa pré-cortada 640 e 960	45/47	25
Susp. longue pré-coupée 640 et 960	45/47	25

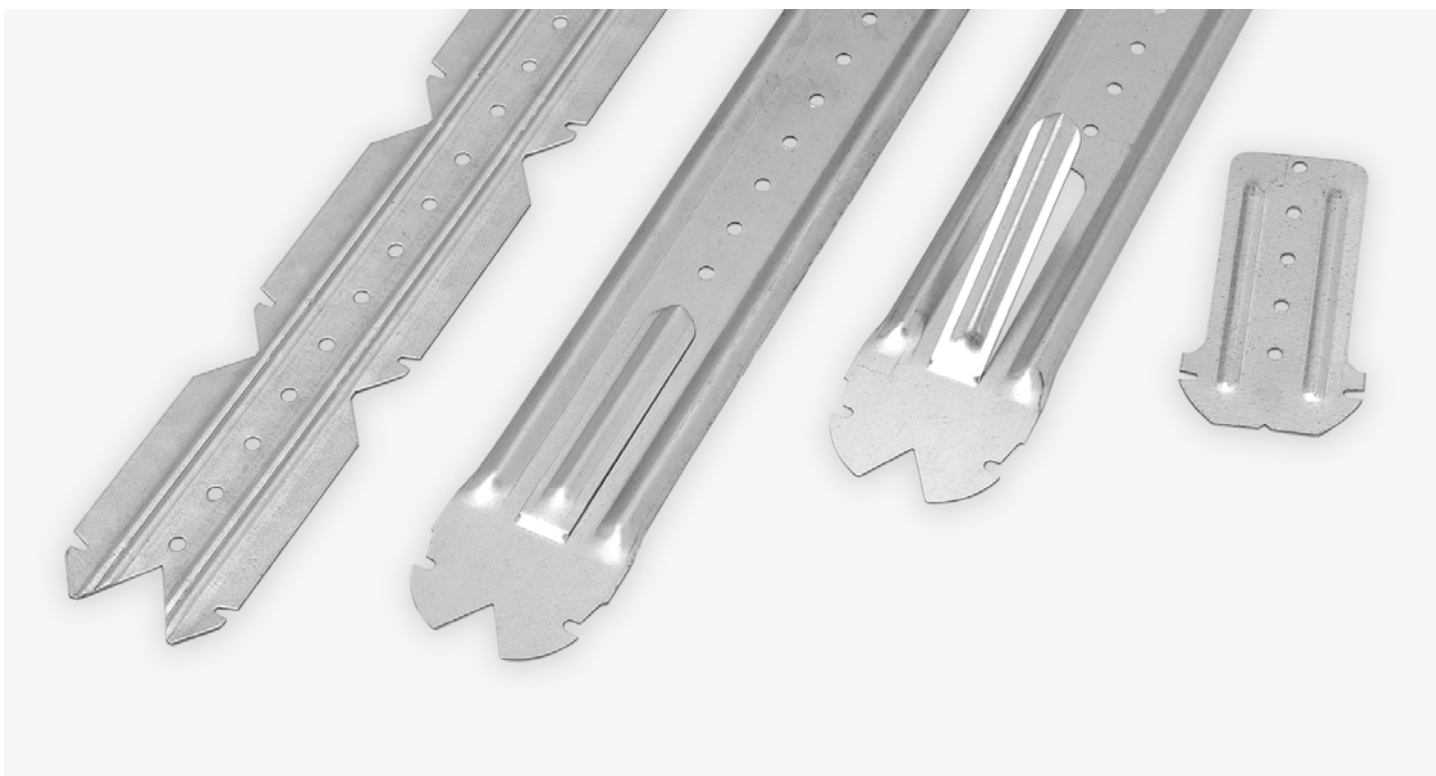

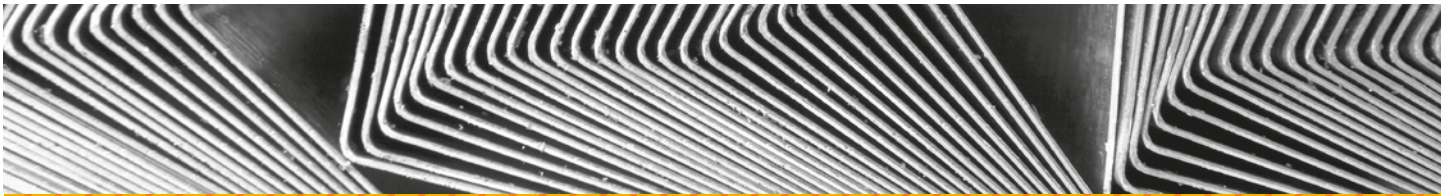

[**VIGA**]

[LONGE PORTÉE]

CE



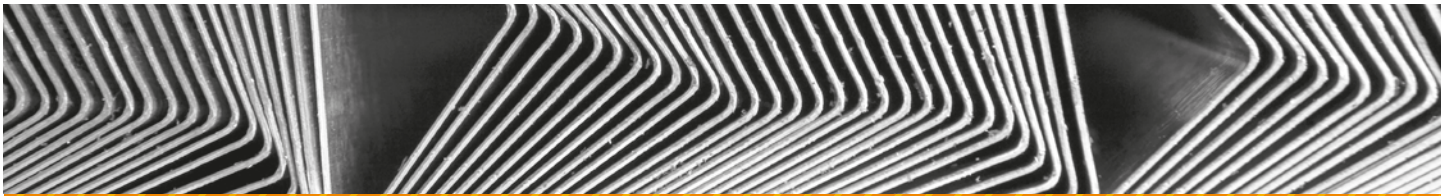

[**VIGA**]

[LONGE PORTÉE]



CE



Produto / Produit	V 54	V 85	V 120
Aba / Ailes	40	40	40
Qtd Paleta / Qte Palette	50	50	50
Norma / Norme CE	✓	✓	✓

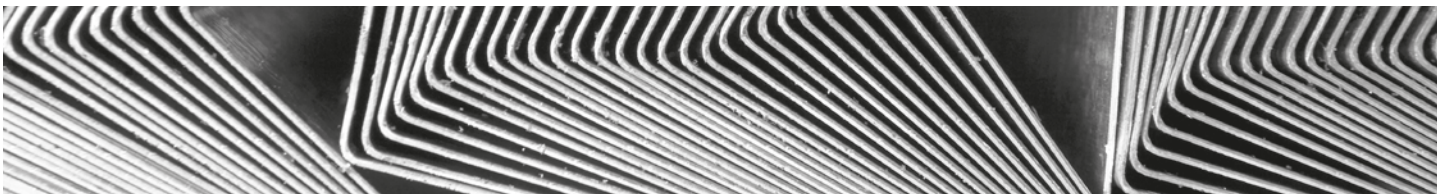

[ACESSÓRIOS PARA VIGA]

[ACCESSOIRES POUR VIGA]



DESIGNAÇÃO DÉSIGNATION		QUANTIDADE POR CAIXA QUANTITÉ PAR BOÎTE
Eclisse direita / droite	54/85/120	25
Raccord viga		25
Raccord viga 90°	54/85/120	25

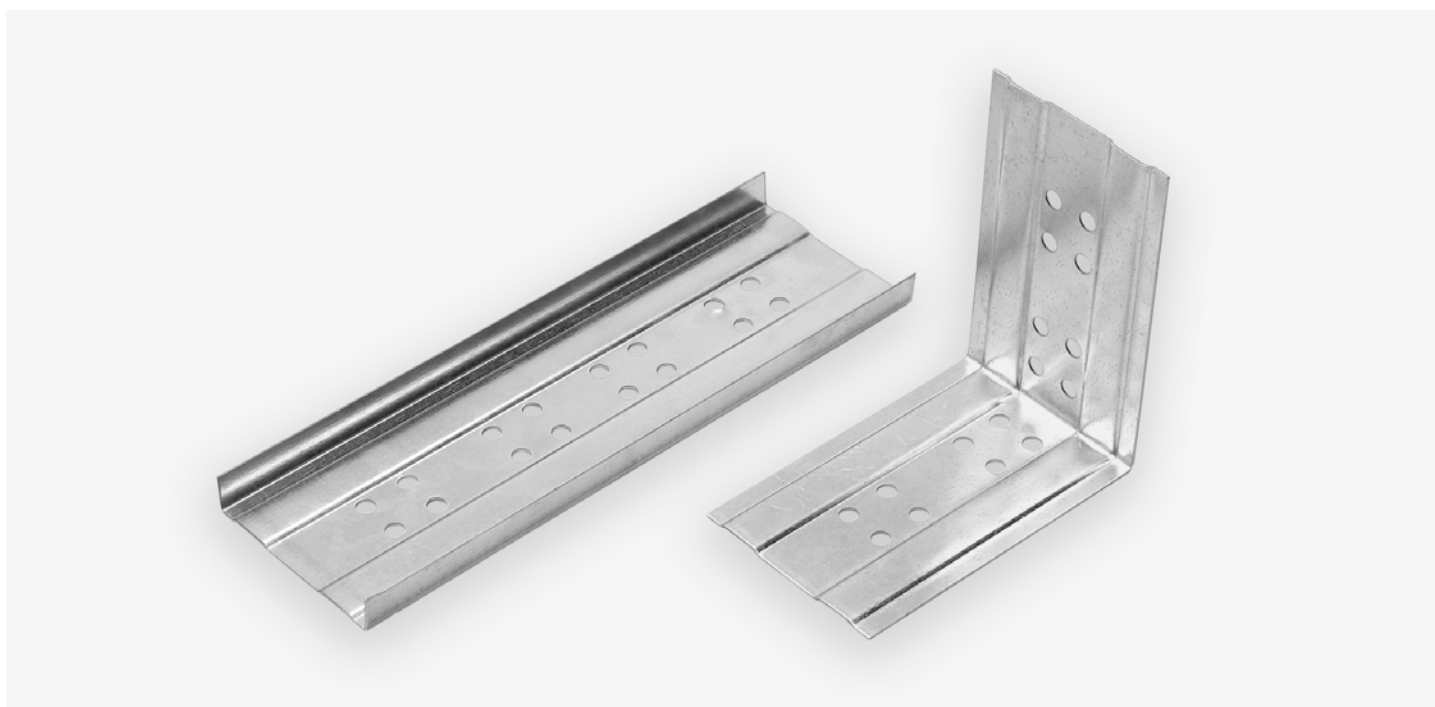

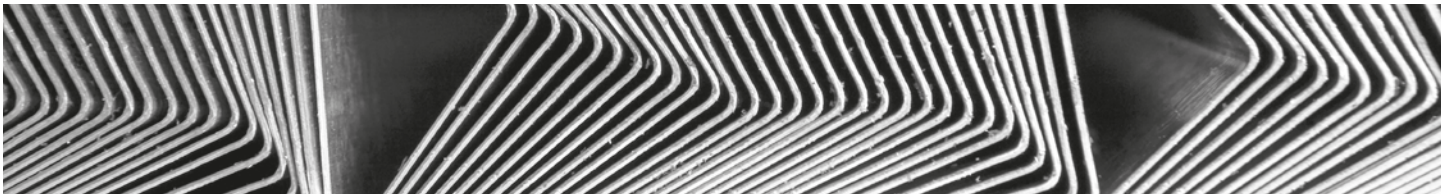

[TABELA DE CARGA LONGO PORTE "VIGA"]

[TABLEAU DES CHARGES LONGUE PORTÉE "VIGA"]

**TABELA DE CARGAS ADMISSÍVEIS POR VIGA COM
AFASTAMENTO DE 1,20m ENTRE APOIOS E FLECHA DE 1/300º**

TABLEAU DES CHARGES ADMISSIBLES POUR LES
OSSATURES "VIGA" ENTRAXE 1,20m ET UNE FLECHE DE 1/300º

- V 120 12 65
- V 120 10 55
- V 85 10 55
- V 85 08 50
- V 85 06 50
- V 54 06 50

Peso de tecto (kg/m²)
Poids du plafond (kg/m²)

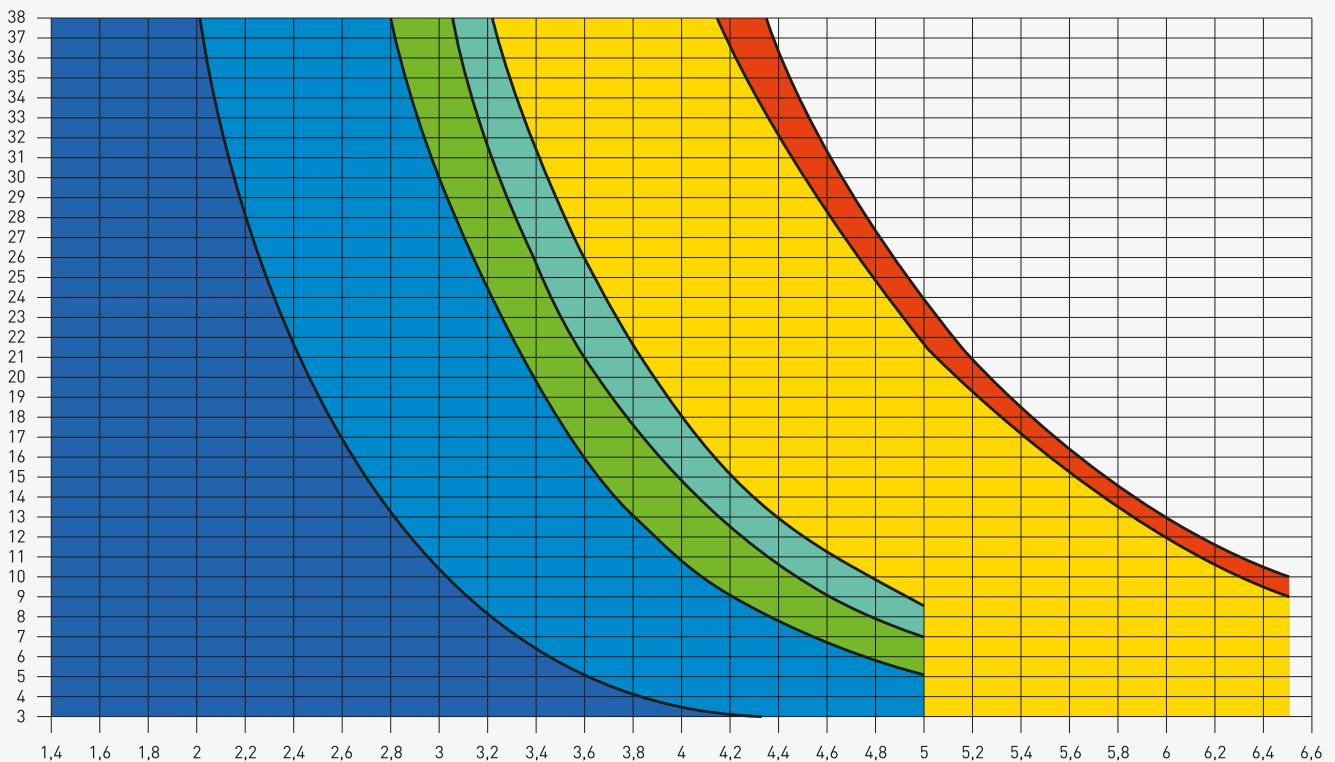

Afastamento entre suspensões (m)
Espace entre suspentes (m)

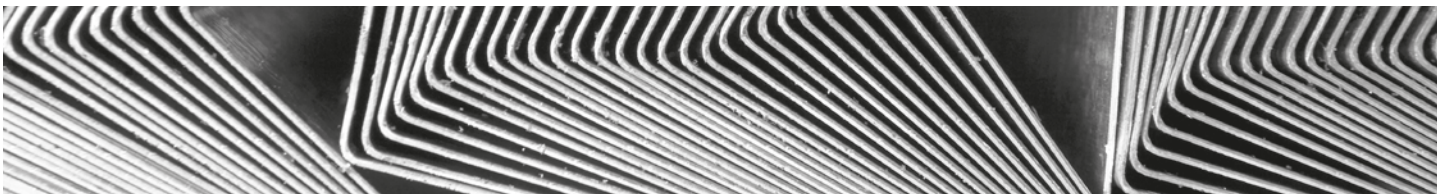

[LOGÍSTICA]

[LOGISTIQUE]

CONDIÇÕES DE ARMAZENAMENTO

- Armazenamento em superfícies cobertas e ventiladas.
- Não expor à chuva nem a ambientes húmidos.
- Armazenar as paletes com a distância entre elas que permita a correcta ventilação do produto.
- Em caso de armazenamento exterior (não recomendado) coloque o material com uma ligeira inclinação para permitir que qualquer tipo de infiltração escorra livremente.

RÈGLES DE STOCKAGE

- Stocker dans un lieu couvert et ventilé.
- Ne pas exposer à la pluie ni dans des lieux humides.
- Stocker les palettes distantes entre elles afin de permettre une bonne ventilation du produit.
- En cas de stockage à l'extérieur (non recommandé) placer les palettes légèrement inclinées afin d'éliminer tout type d'infiltration.





Parque Industrial Manuel da Mota
Lote 21
3100-354 Pombal
PORTUGAL

T: (00 351) 236 211 543 [Chamada para rede fixa nacional]
F: (00 351) 236 211 544
E: geral@gramperfil.com
comercial@gramperfil.com

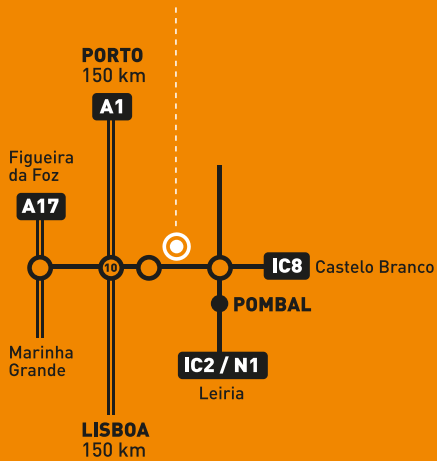

GramPerfil

www.gramperfil.com